

**The design and evaluation of
new technologies to support
people with dementia**

Roger Orpwood

Bath Institute of Medical Engineering

University of Bath



Enabling smart homes

```
graph TD; A[Enabling smart homes] --> B[Quality of life]; B --> C[Service implementation]; C --> D[Evaluations];
```

Quality of life

Service implementation

Evaluations

Enabling smart homes

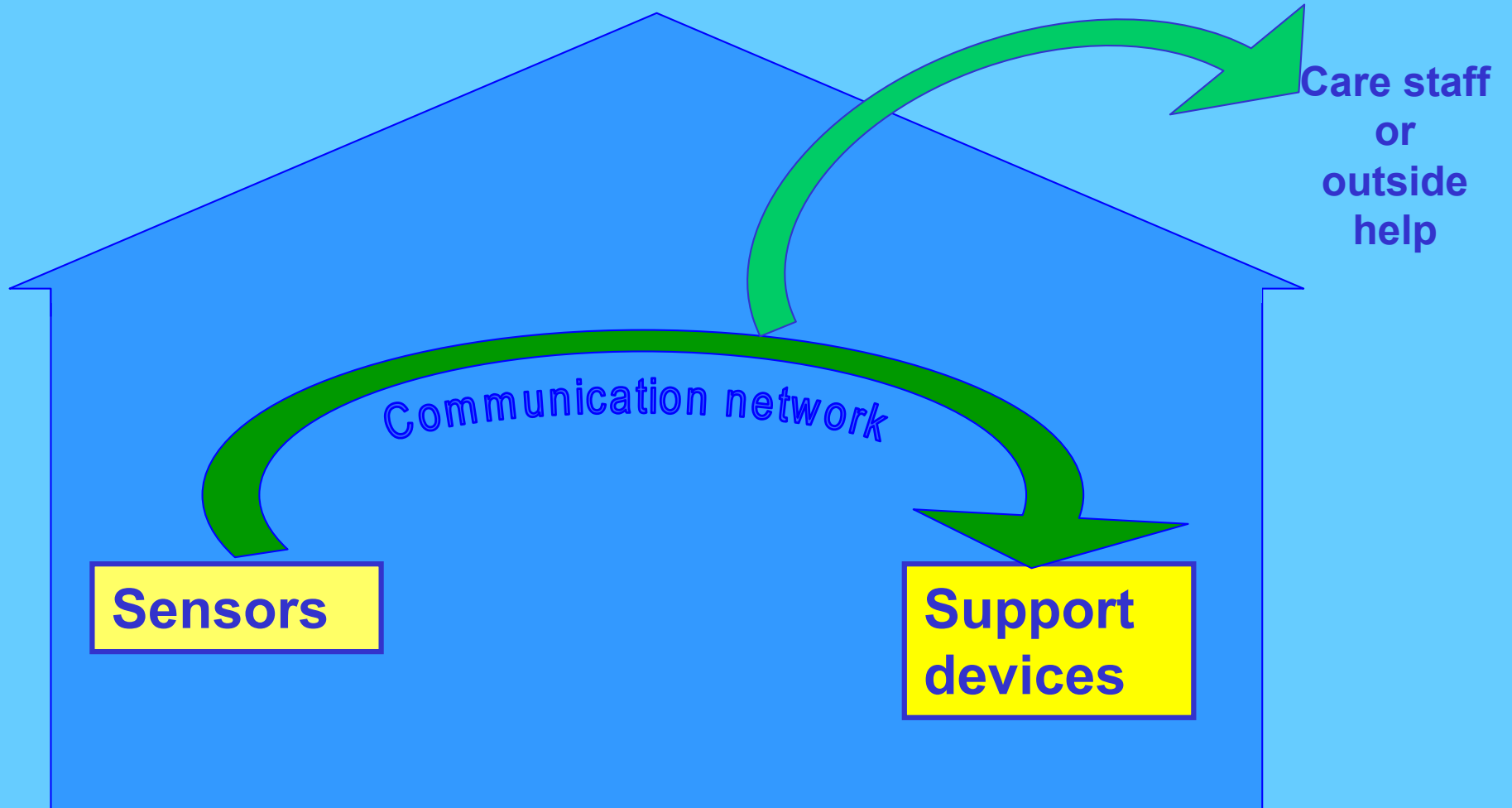

Carer emulation

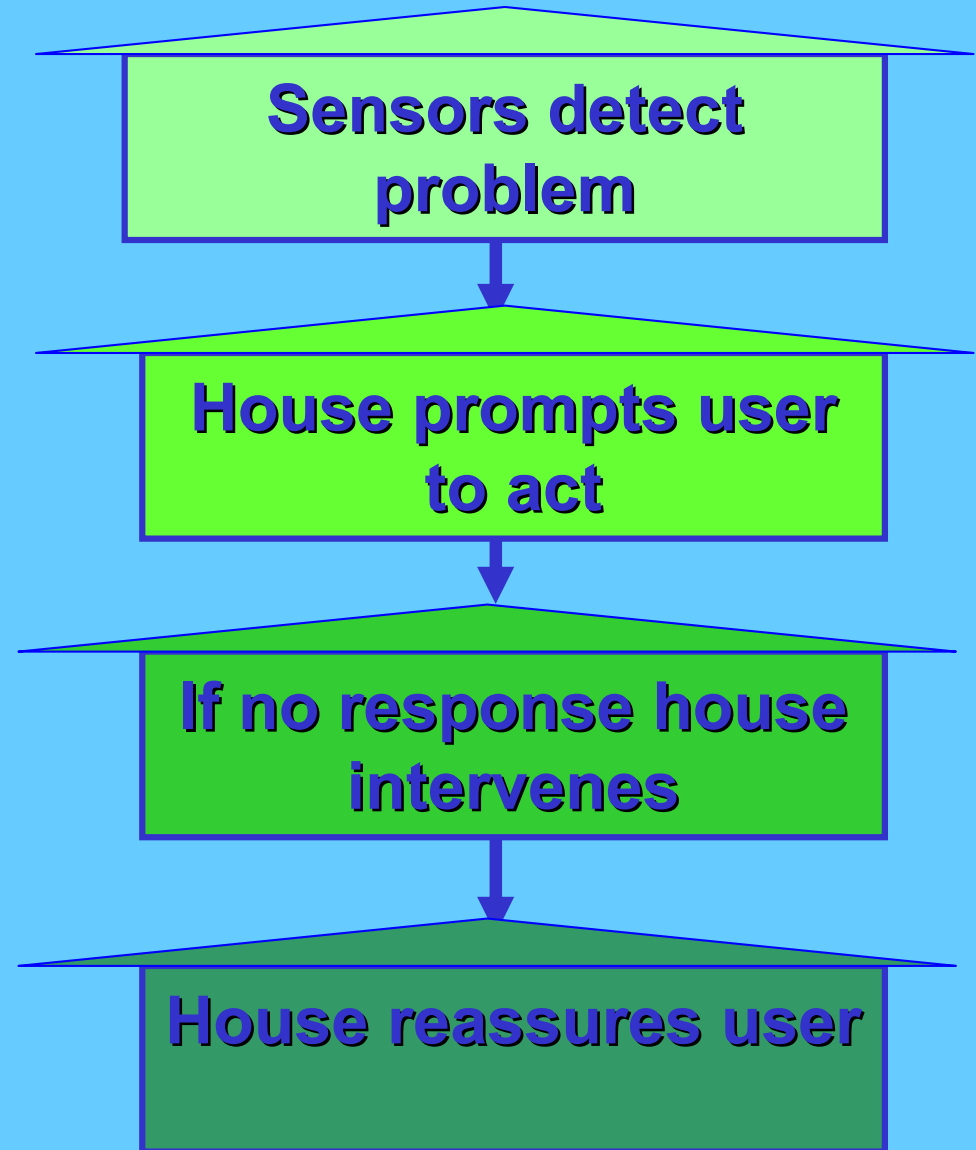
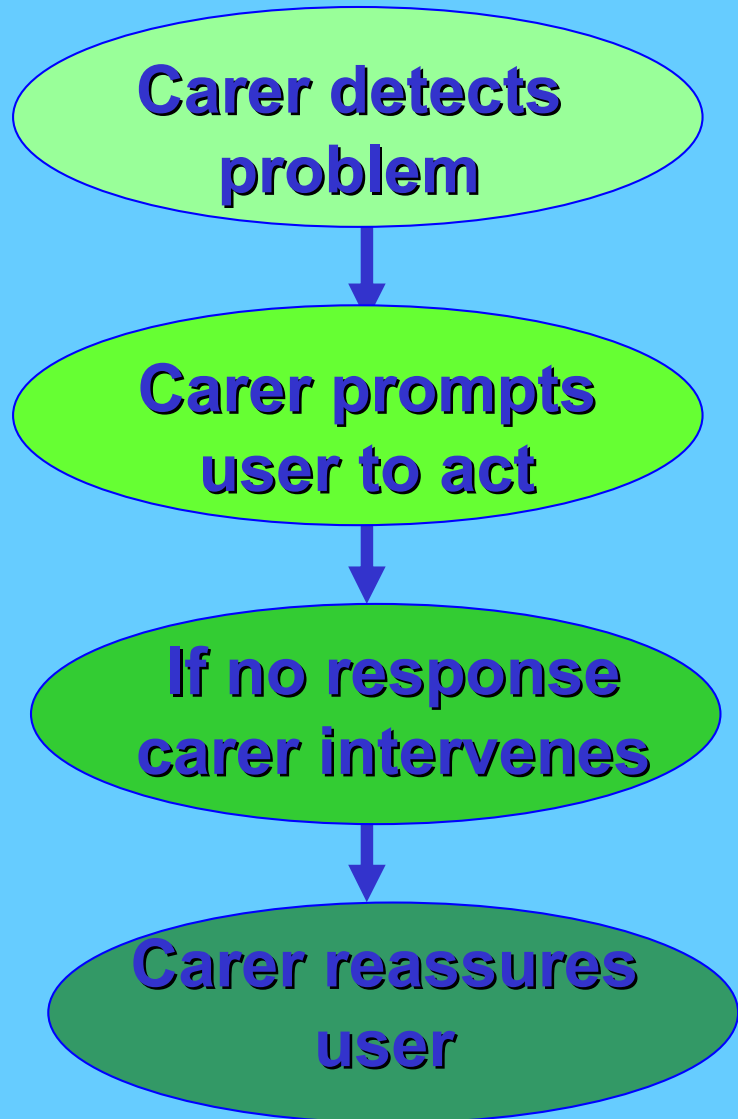

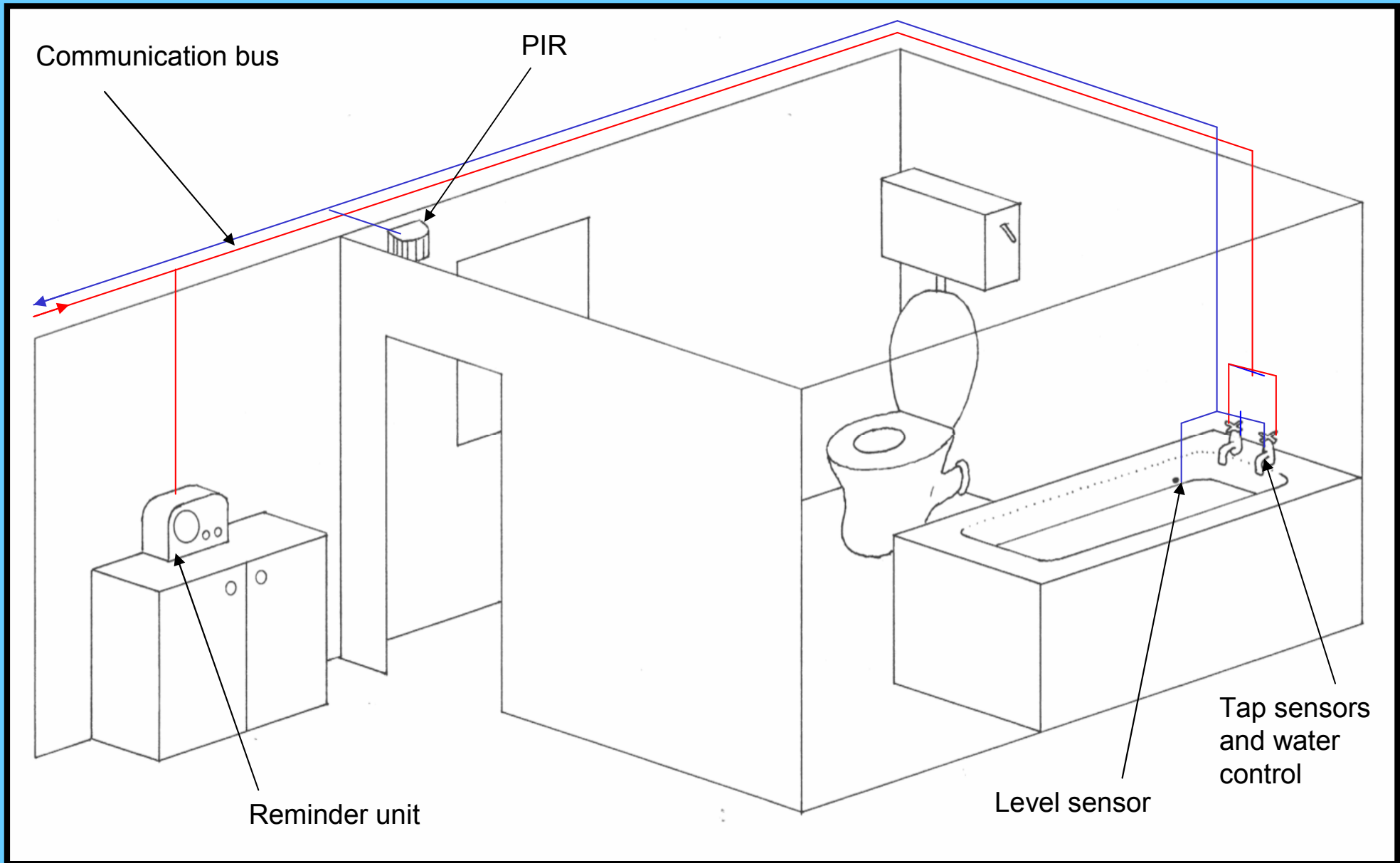

Gloucester smart house

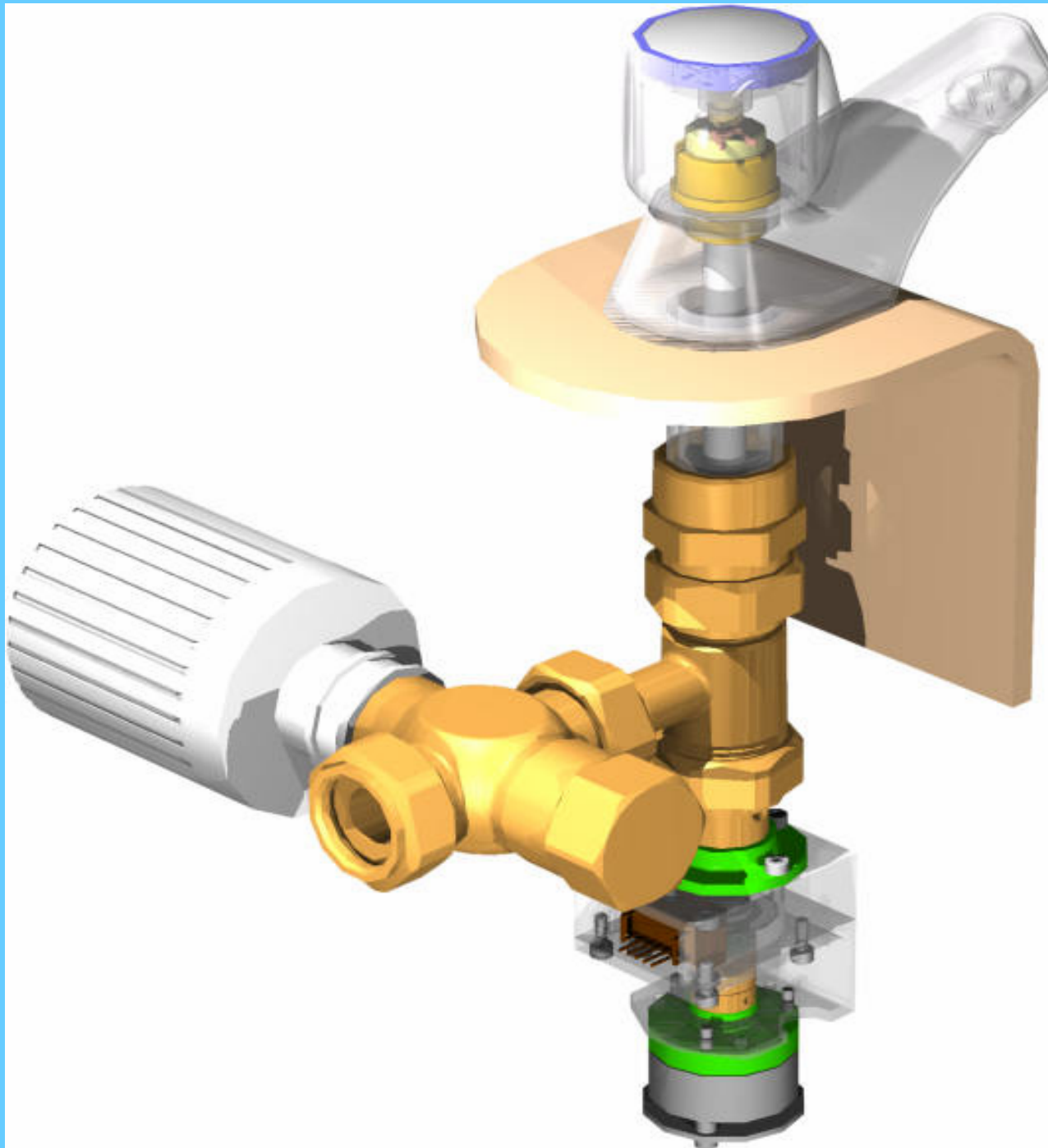



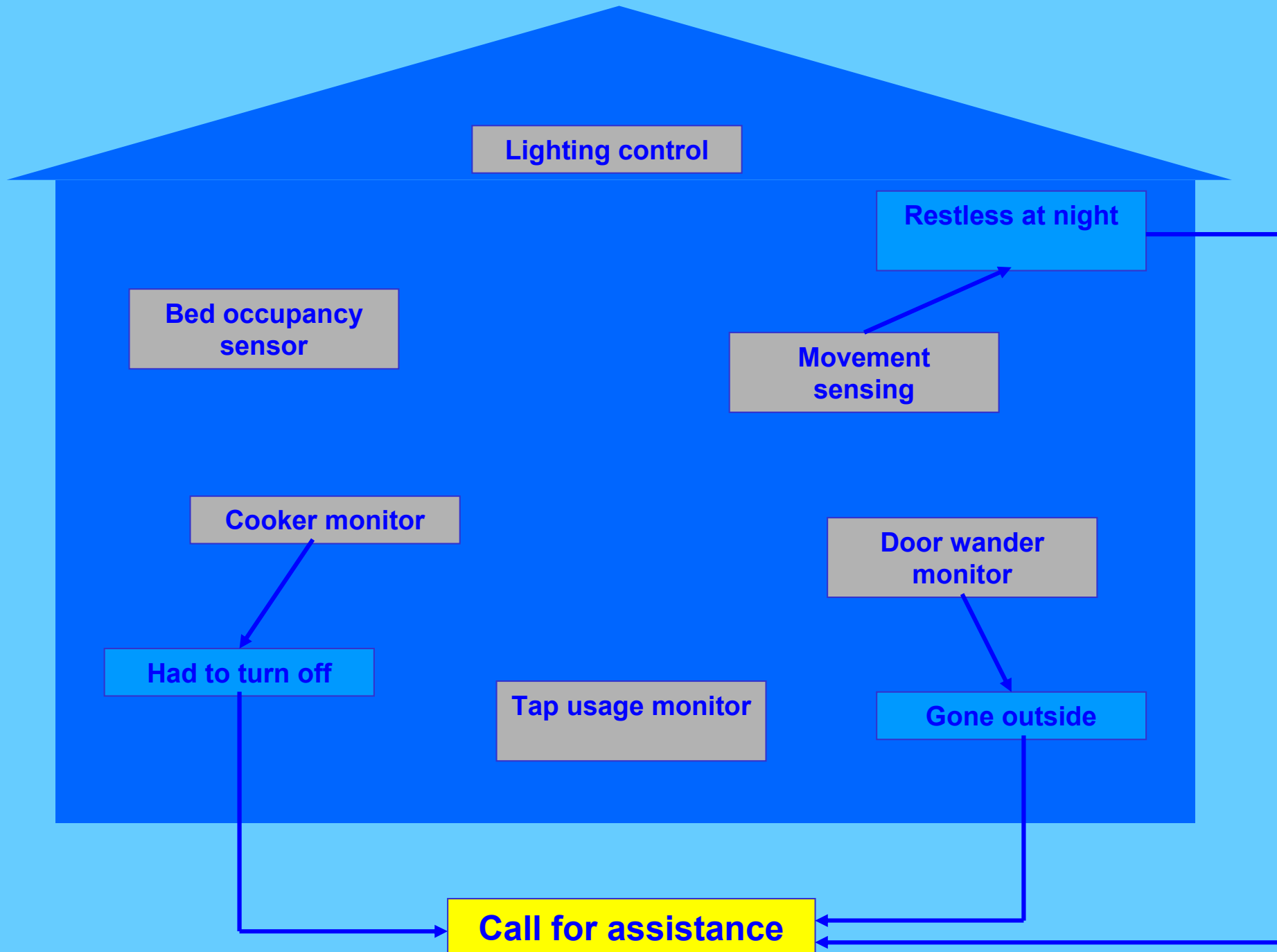

Quality of life

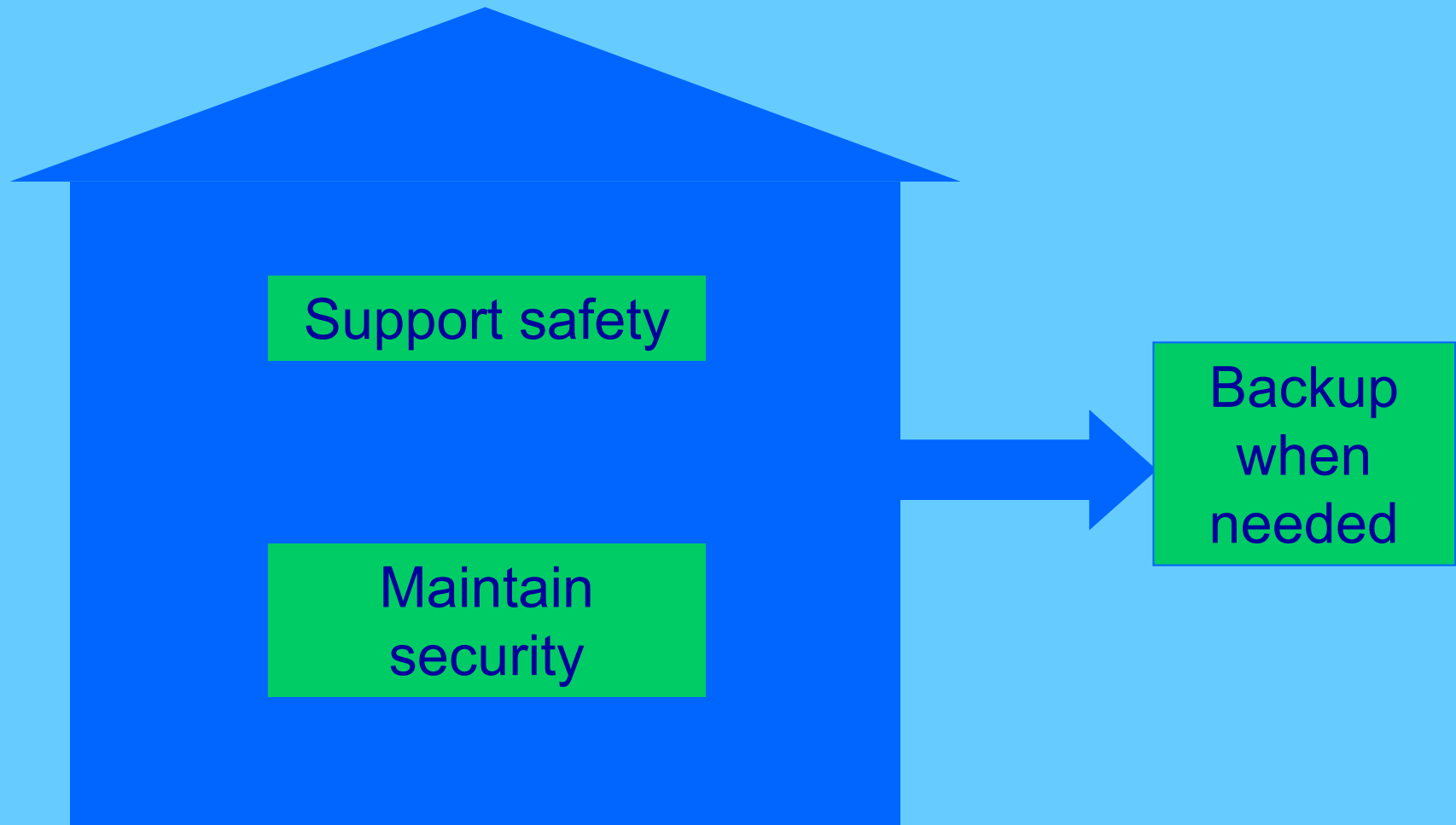

But there is more to life than just being safe and secure.....

Approach developed

Technology design



QoL outcome measure

QoL Interviews



QoL Issues



Technology design

independent

W
i
s
h
i
s
t

- **identity and personal history**
- **enabling relationships**
- **encouraging social engagement**
- **conversation prompting**
- **music**
- **supporting activity sequences**
- **access to nature**
- **creative activities**

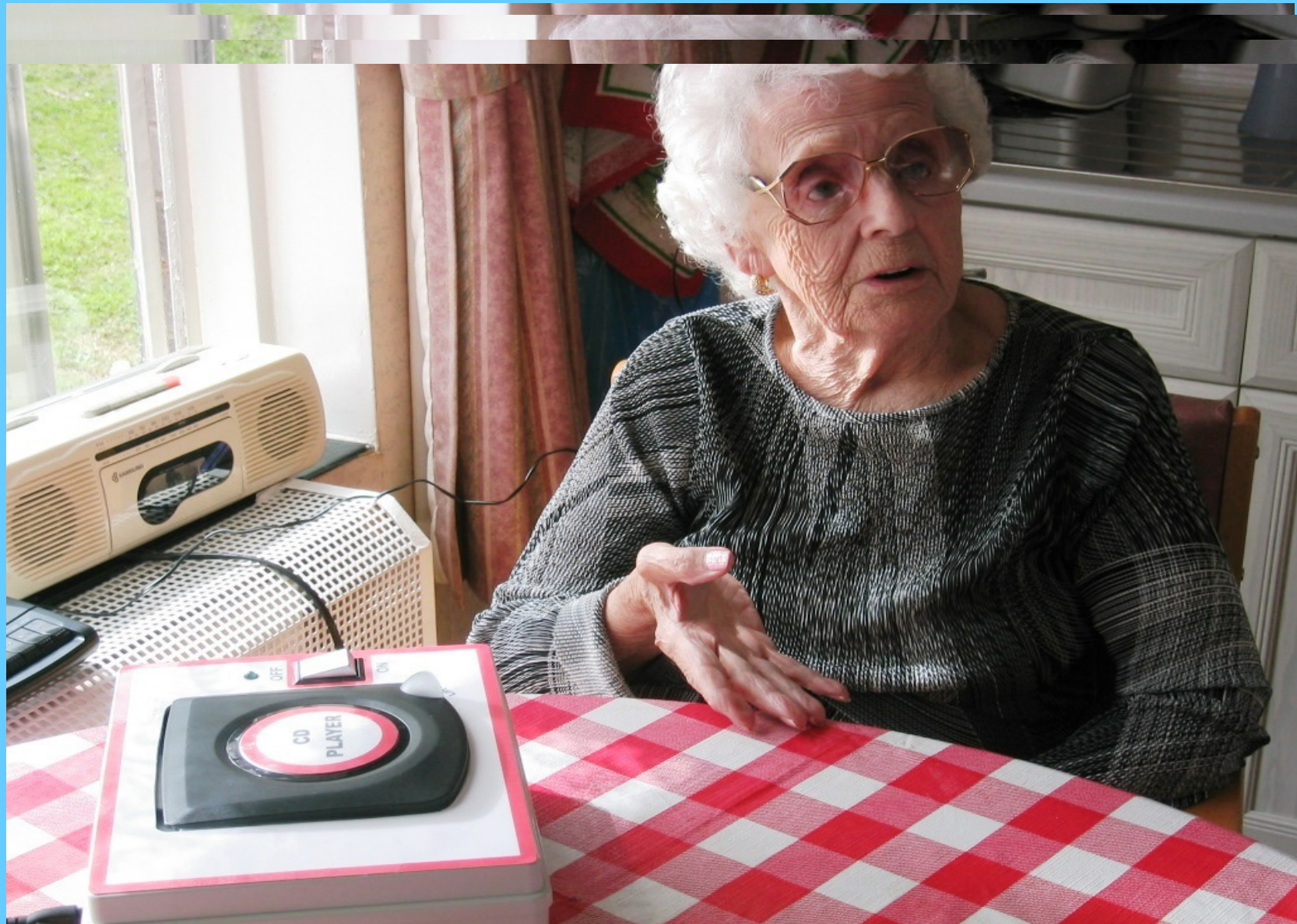



Open lid to
listen to music



Service implementation

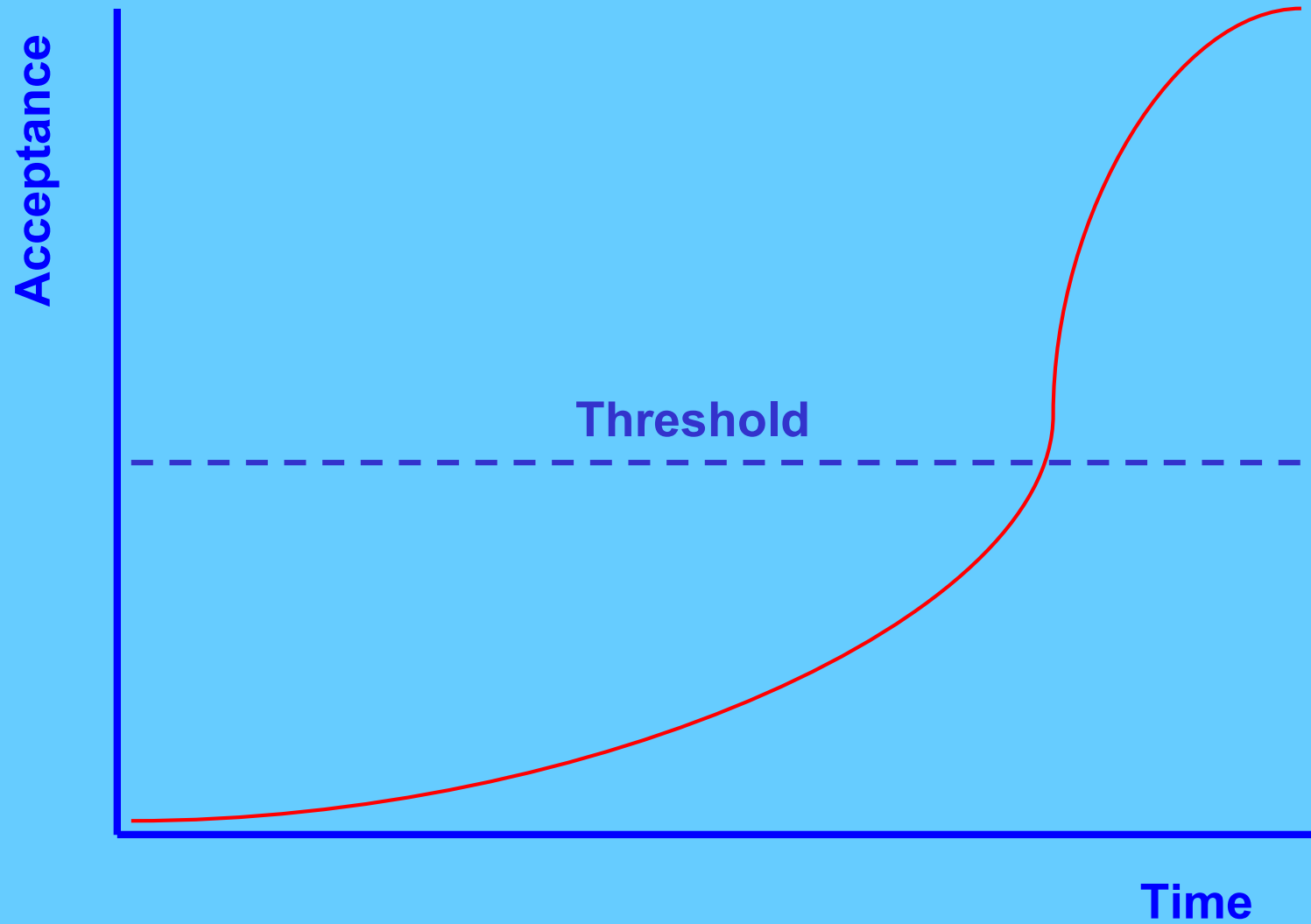

Acceptance of innovation

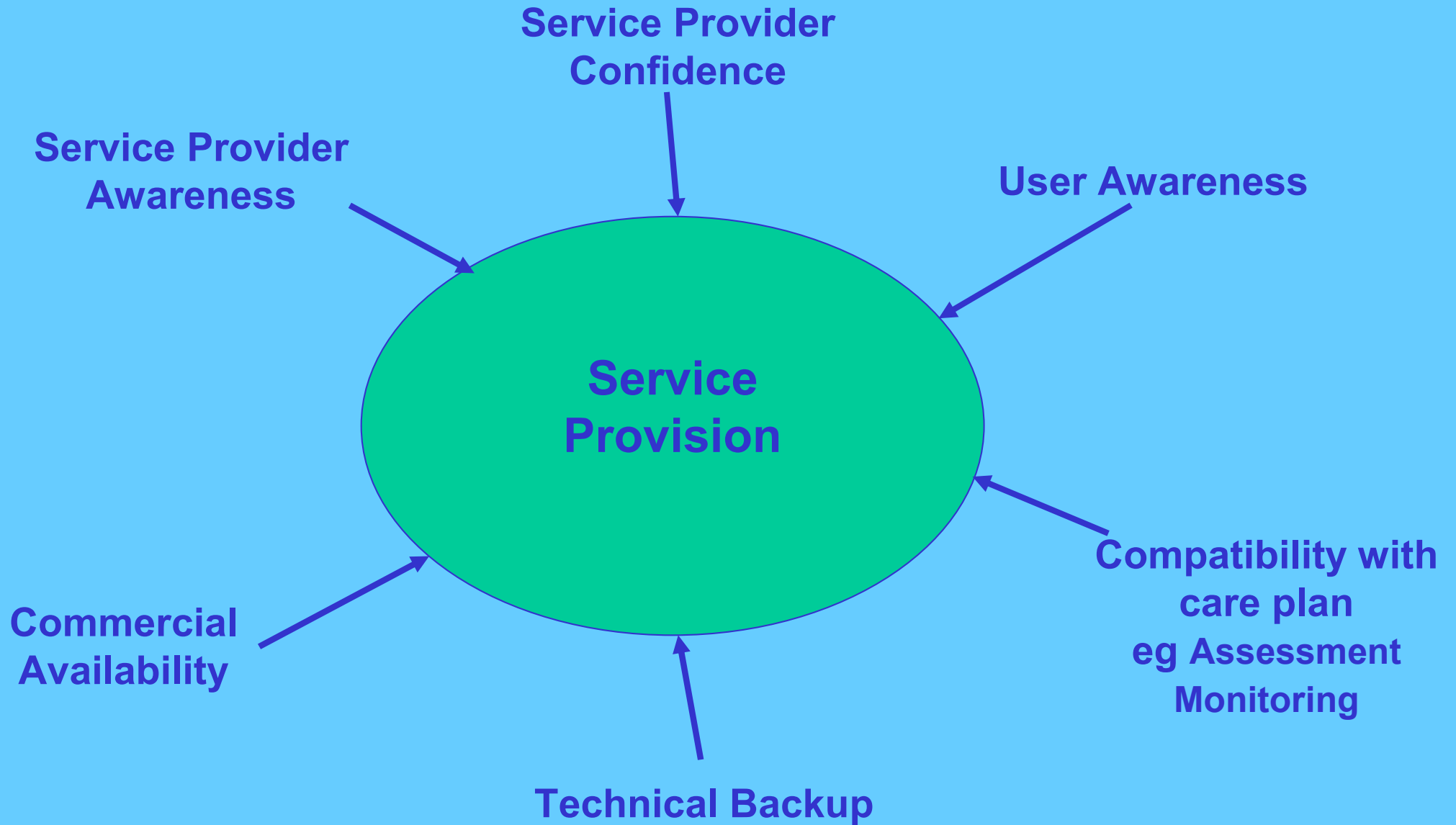

Our plan

User-led development work

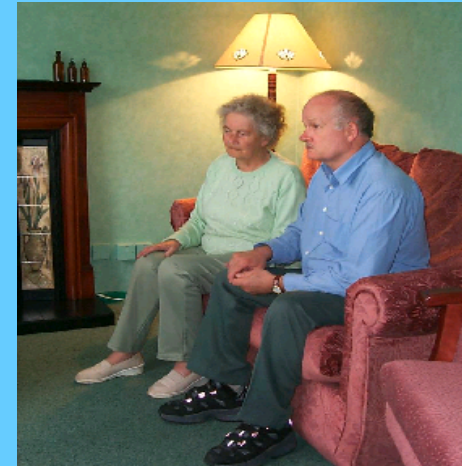

Evaluations of stand-alone devices



Evaluations of complete installations

Stand-alone devices



Evaluations

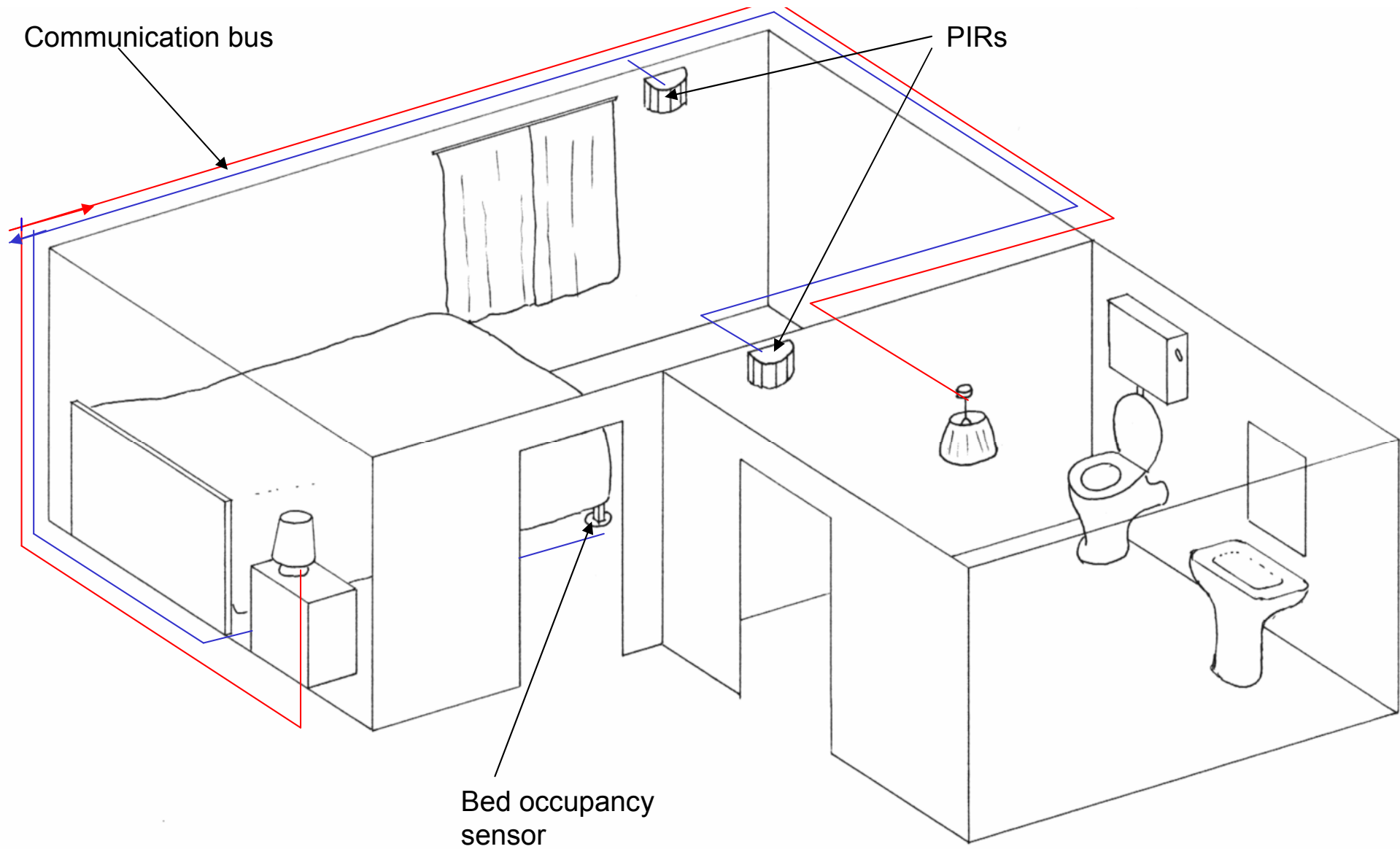



Bathroom

Hall

Kitchen

Lounge

Bedroom

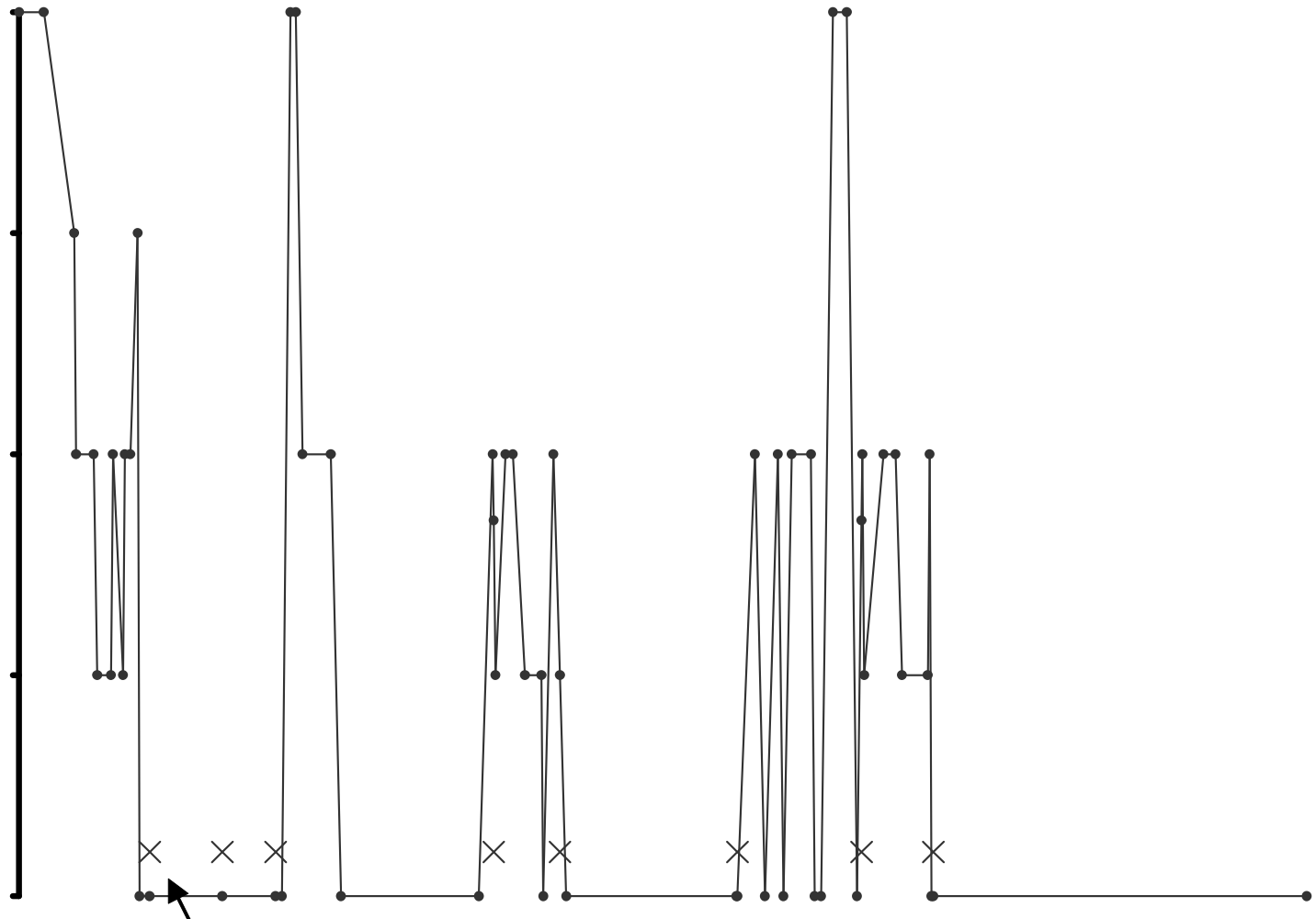

Bed Occupancy

Time

User behaviour

House reaction

Get out of bed at night

Bed
occupancy
sensor

Light fade on

"I've turned the toilet light
on for you dad"

Wander for a while

PIR

No action

Wander for >10 minutes

PIR

"You should go back to
bed now dad"

Get back into bed

Bed
occupancy
sensor

Light fades off after 3 mins

Still wandering after 15
mins

PIR

Care staff alerted

Impact on sleep duration

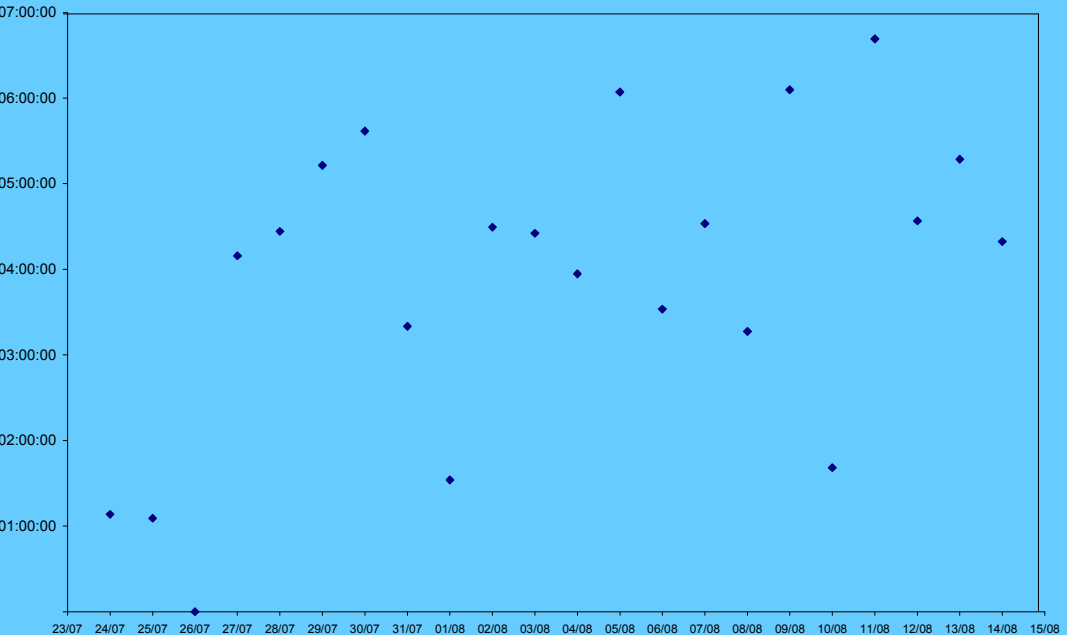

Just sensing

Support turned on

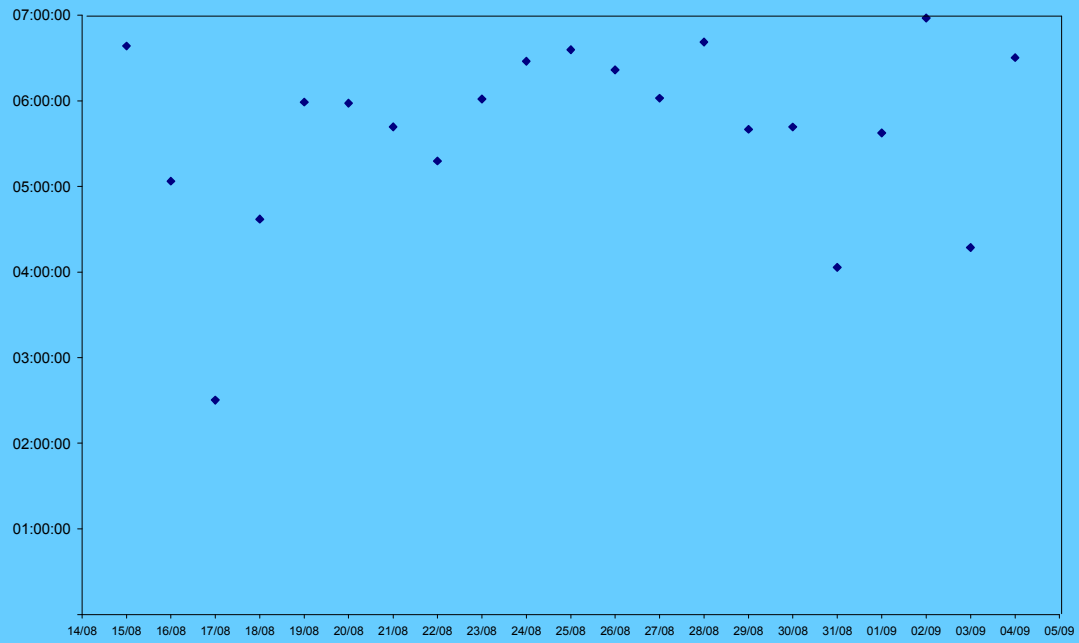

www.bime.org.uk



Work supported by EPSRC EQUAL programme, European Commission, and various medical charities, to whom we are very grateful